

Handheld Fiber Microscope Operation instruction

1 Front panel function description

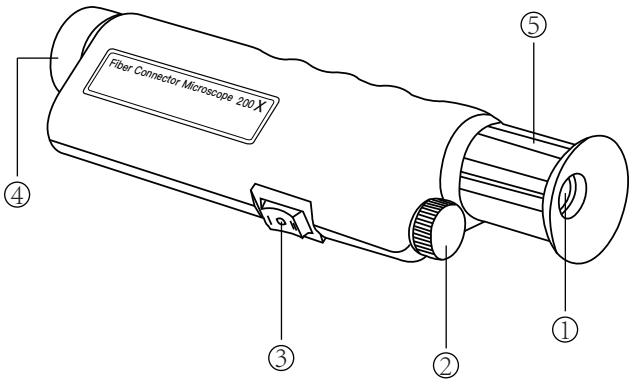

- ① Eyepiece: Optical fiber end face viewing window
- ② Battery cover: unscrew to put the battery
- ③ Switch: Two different lighting modes can be selected
- ④ Adapter interface: including 1.25 mm and 2.5 mm universal adapters
- ⑤ Focus knob: adjust the focus of the knob to check the clarity of the fiber end face

2 Two lighting modes

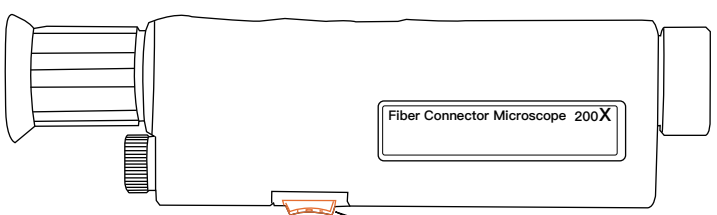

Toggle "I" to jump to the axial illumination, toggle "II" to jump to the side illumination, and toggle "o" to directly turn off.

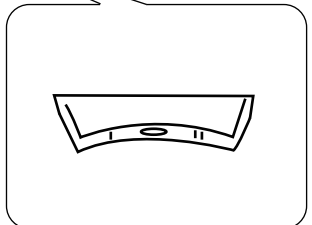

4 Eyepiece viewing

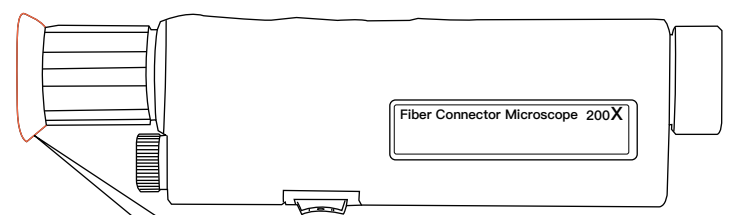

Holding the fiber optic microscope with one hand, aiming at the eyepiece with a single eye, you can accurately check whether the fiber end face needs to be cleaned.

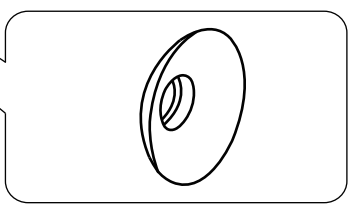

5 Ocus knob

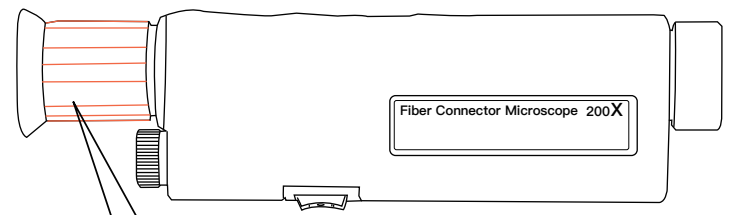

Align the eyepiece and adjust the focal length of the knob to clearly check the degree of dirt on the end face.

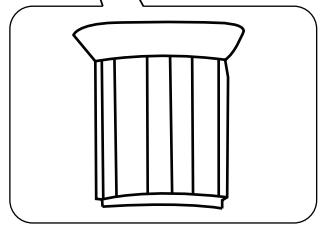

3 Battery cover

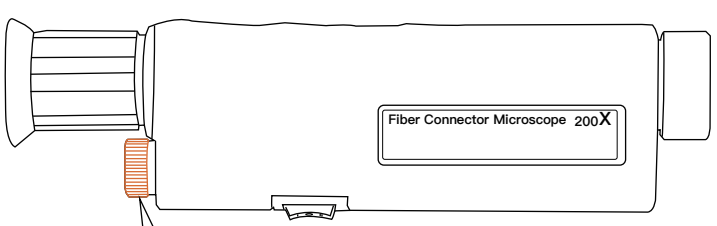

The first step is to unscrew the battery cover, and the second step is to put the battery in, and the battery can be replaced and used in time.

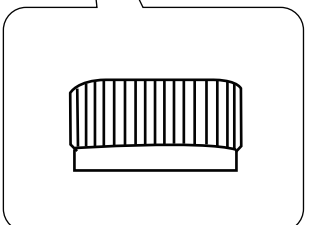

6 Universal adapter

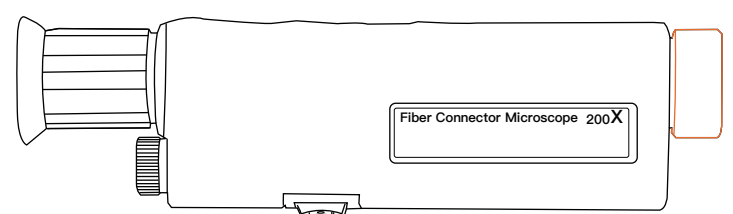

Universal adapter interface, respectively 1.25mm and 2.5mm is appropriate interfaces Orchestration.



Handheld Fiber Microscope Operation instruction

7

product description

The hand-held fiber optic microscope is a fiber end face detector. With its high-end optics, it can quickly manually focus and detect scratches, dirt, and dust on the fiber end face. The product supports UPC's SC, FC, ST, LC male heads, with good optical performance and integrated laser safety filter, whether it is tested on the production line or on-site, allowing your technicians to quickly find scratches, fiber end dirt.

8

Product features

- 200 times magnification, the fiber end face is clearly visible.
- The frosted silicone shell is non-slip, drop-proof and shock-proof.
- Support SC, FC, ST, and LC male headers of UPC.
- Imported coated lens, fouling is clearly visible.
- 3*LR44 button battery 6F22 (need to buy by yourself).
- Manually adjust the focus quickly.
- Small size, can be held with one hand, convenient and fast.
- 100,000 hours of LED lighting, 20 hours of standby.

9

Product parameter

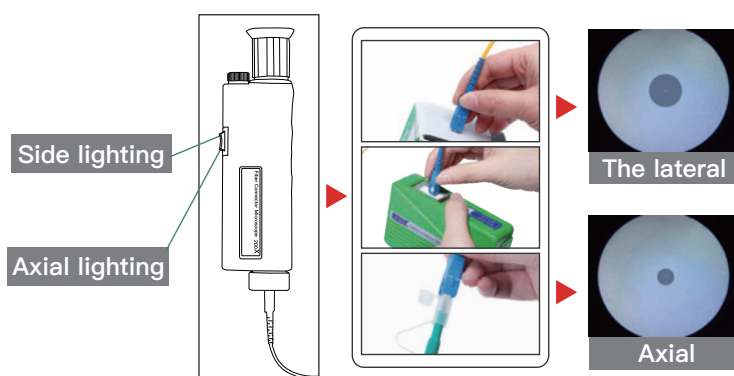

➤ Support SC/FC/ST/LC

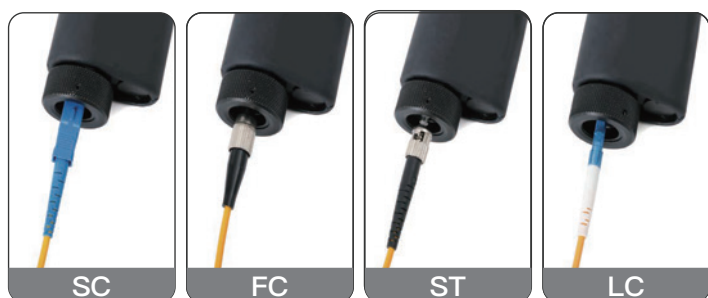

10

Product parameter

Magnification	200 times & 400 times
Light source and usage time	White LED, service life of 100,000 hours; Battery life of 40 hours
Size	225mm x 60mm x 42mm
Adapter interface	Includes 1.25 mm and 2.5 mm universal adapters
Interface Type	SC, FC, ST, LC
Overview	Host 1.25 mm and 2.5 mm adapter nylon black bag; LR44 button battery 6F22 (need to purchase by yourself); Packing box.

➤ Use environment

- Operating environment altitude:
areas below 2000m above sea level

11

Tips

⚠ Please read all instructions and warnings before using this product. Irregular use will cause damage to the product or personal safety.

- 1) Do not store this product in high temperature, strong light and strong magnetic fields, and do not place it in other harsh environments such as fire sources.
- 2) Improper use of the product may easily cause the product damage or may endanger personal and property safety.
- 3) If consumers violate the product manual and improperly use it, the personal and property damage caused by it will be borne by yourself, our company will not bear any legal responsibility.
- 4) Non-professionals are strictly prohibited from disassembling this product.
- 5) Avoid using electrical appliances or loads that exceed the output current of this product (the circuit will be protected and there will be no output).
- 6) Avoid strong physical effects, including knocking, throwing, trampling, squeezing, etc.

➤ Standard configuration

- Nylon carrying bag, product host, battery, adapter interface.